



XLC-40-MAS Series
(Independent type)



XLC-40-MA Series
(Built-in type)



Features

- Constant power mode output with multiple stage selectable by DIP switch
- Plastic housing with class II and PFC design
- Flicker free, complying with CE ErP directive
- Standby power consumption <0.5W
- Meet emergency lighting (EL) function application
- Minimum dimming level 0.5%
- Matter over thread, Matter 1.3 specification
- 5 years warranty

Applications

- Recessed Light
- Down Light
- Panel Light
- Commercial Lighting
- Decorative Lighting
- Matter wireless Lighting

GTIN CODE

MW Search: <https://www.meanwell.com/serviceGTIN.aspx>

Description

XLC-40-MA series is a 40W with constant power output LED driver . It can operate from 100~305VAC and output current ranging between 600 mA to 1400 mA selectable by DIP switch . Thanks to high efficiency up to 88%, it is able to operate for -25°C~90°C case temperature under free air convection. XLC-40-MA series is designed based on latest safety regulations with Matter wireless dimming.It provides more flexibility for LED Lighting application.

Model Encoding

XLC - 40 - H - MA □

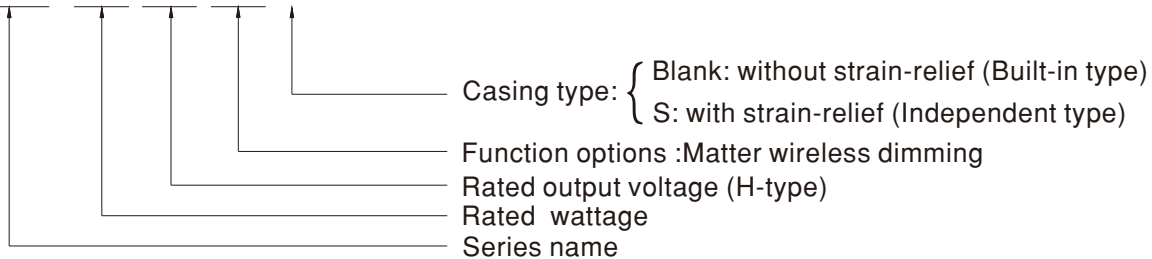

Type	Function	Note
MA	Output current selectable by DIP switch, without strain-relief (Built-in type)	In stock
MAS	Output current selectable by DIP switch, with strain-relief (Independent type)	In stock

SPECIFICATION

MODEL		XLC-40-H-MA <input type="checkbox"/>		
OUTPUT	OPEN CIRCUIT VOLTAGE	Note.2	60V	
	DEFAULT CURRENT		1050mA	
	CURRENT ADJ. RANGE (BY DIP SWITCH)		0.6~1.4A	
	CONSTANT CURRENT REGION	Note.3	9~54V	
	RATED POWER	Note.4	40W	
	CURRENT RIPPLE		<4%(@full load)	
	CURRENT TOLERANCE		±5%	
	DIMMING RANGE		0~100%	
SETUP, RISE TIME	Note.5	2500ms, 100ms/230VAC, 2500ms, 100ms/115VAC		
INPUT	VOLTAGE RANGE	100 ~ 305VAC 141 ~ 400VDC		
	FREQUENCY RANGE	47 ~ 63Hz		
	POWER FACTOR	PF ≥ 0.97/115VAC, PF ≥ 0.95/230VAC, PF ≥ 0.92/277VAC@full load (Please refer to "POWER FACTOR (PF) CHARACTERISTIC" section)		
	TOTAL HARMONIC DISTORTION	THD<10%(@load ≥ 50%/230VAC; @load ≥ 75%/277VAC), THD<15%(@load ≥ 50%/115VAC) (Please refer to "TOTAL HARMONIC DISTORTION(THD)" section)		
	EFFICIENCY (Typ.)	Note.6	88%	
	AC CURRENT	0.5A / 115VAC 0.25A / 230VAC 0.2A/277VAC		
	INRUSH CURRENT(Typ.)	COLD START 10A(twidth=100μs measured at 50% Ipeak) at 230VAC; Per NEMA 410		
	MAX. No. of PSUs on 16A CIRCUIT BREAKER	51 units (circuit breaker of type B) / 51 units (circuit breaker of type C) at 230VAC		
	LEAKAGE CURRENT	<0.75mA / 277VAC		
	STANDBY POWER CONSUMPTION	Note.7	Standby power consumption<0.5W(Dimming off)	
PROTECTION	SHORT CIRCUIT	Hiccup mode, recovers automatically after fault condition is removed		
	OVER TEMPERATURE	Stage 1: De-rating to 75% loading; Stage 2: De-rating to 50% loading. Recovers automatically after fault condition is removed.		
ENVIRONMENT	WORKING TEMP.	Tcase=-25 ~ 90°C (Please refer to " OUTPUT LOAD vs TEMPERATURE" section)		
	MAX. CASE TEMP.	Tcase=90°C		
	WORKING HUMIDITY	20 ~ 90% RH non-condensing		
	STORAGE TEMP., HUMIDITY	-40 ~ +80°C, 10 ~ 95% RH		
	TEMP. COEFFICIENT	±0.03%/°C (0 ~ 50°C)		
VIBRATION	10 ~ 500Hz, 2G 10min./1cycle, period for 60min. each along X, Y, Z axes			
SAFETY & EMC	SAFETY STANDARDS	ENEC BS EN/EN61347-1, BS EN/EN61347-2-13(EL) appendix J suitable for emergency installations(DC input 176-280VDC); BS EN/EN62384, GB/T 19510.1, GB/T 19510.213, EAC TP TC 004; CSA C22.2 No. 250.13-12 approved; Design refer to AS/NZS 61347-1, AS/NZS 61347-2-13;		
	WITHSTAND VOLTAGE	I/P-O/P: 3.75KVAC		
	ISOLATION RESISTANCE	I/P-O/P: >100M Ohms / 500VDC / 25°C / 70% RH		
	EMC EMISSION	Parameter	Standard	Test Level/Note
		Conducted	BS EN/EN55015(CISPR15) ,GB/T 17743	-----
		Radiated	BS EN/EN55015(CISPR15) ,GB/T 17743	-----
		Harmonic Current	BS EN/EN61000-3-2, GB17625.1	Class C @load≥50%
	Voltage Flicker	BS EN/EN61000-3-3	-----	
	EMC IMMUNITY	BS EN/EN61547		
		Parameter	Standard	Test Level/Note
		ESD	BS EN/EN61000-4-2	Level 3, 8KV air ; Level 2, 4KV contact
		Radiated	BS EN/EN61000-4-3	Level 2
		EFT/Burst	BS EN/EN61000-4-4	Level 2
Surge		BS EN/EN61000-4-5	Level3, 1KV/Line-Line	
Conducted		BS EN/EN61000-4-6	Level 2	
Magnetic Field		BS EN/EN61000-4-8	Level 2	
Voltage Dips and Interruptions	BS EN/EN61000-4-11	70% residual voltage for 10 period, 0% residual voltage for 0.5 periods		
OTHERS	MATTER STANDARD	Matter 1.3 Specification		
	FLICKER	Note.8	PstLM ≤ 1, SVM ≤ 0.4	
	MTBF	3935.2 K hrs min. Telcordia SR-332 (Bellcore); 342.9 Khrs min. MIL-HDBK-217F (25°C)		
	DIMENSION	147*40*32mm,107*40*32mm (L*W*H)		
	PACKING	193g; 60pcs/12.58Kg/0.58CUFT(for blank type); 210g; 50pcs/11.5Kg/0.57CUFT(for S-type)		
NOTE	<p>1. All parameters NOT specially mentioned are measured at 230VAC input, rated current and 25°C of ambient temperature.</p> <p>2. Output hiccups under no-load condition.</p> <p>3. Please refer to "DRIVER METHODS OF LED MODULE".</p> <p>4. De-rating may be need under low input voltages. Please refer to "STATIC CHARACTERISTIC" sections for details.</p> <p>5. Length of set up time is measured at first cold start. Turning ON/OFF the driver may lead to increase of the set up time.</p> <p>6. Efficiency is measured at 800mA/50V output set by dip-switch.</p> <p>7. Standby power consumption is measured at 230VAC.</p> <p>8. Flicker is measured at full load with LED modules.</p> <p>9. The driver is considered as a component that will be operated in combination with final equipment. Since EMC performance will be affected by the complete installation, the final equipment manufacturers must re-qualify EMC Directive on the complete installation again. (as available on https://www.meanwell.com/Upload/PDF/EMI_statement_en.pdf)</p> <p>10. For XLC-S series: RCM is on a voluntary basis. Non IC classification Independent LED control gear is not suitable for residential installations. For XLC(except -S) series: RCM is on a voluntary basis and meets relevant IEC or AS/NZS standards complying with AS/NZS 4417.1</p> <p>11. This series meets the typical life expectancy of >50,000 hours of operation when Tcase, particularly (C) point (or TMP, per DLC), is about 75°C or less.</p> <p>12. The ambient temperature de-rating of 3.5°C/1000m with fanless models and 5°C/1000m with fan models for operating altitude higher than 2000m(6500ft).</p> <p>13. For more information, please contact with MEAN WELL sales.</p> <p>※Product Liability Disclaimer: For detailed information, please refer to https://www.meanwell.com/serviceDisclaimer.aspx</p>			

BLOCK DIAGRAM

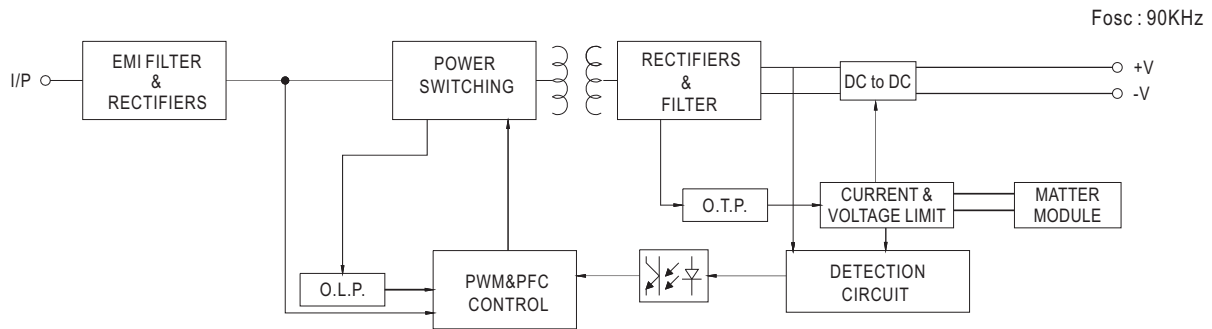

DRIVING METHODS OF LED MODULE

※ I-V Operating Area

◎ XLC-40-H-MA

For 40W application

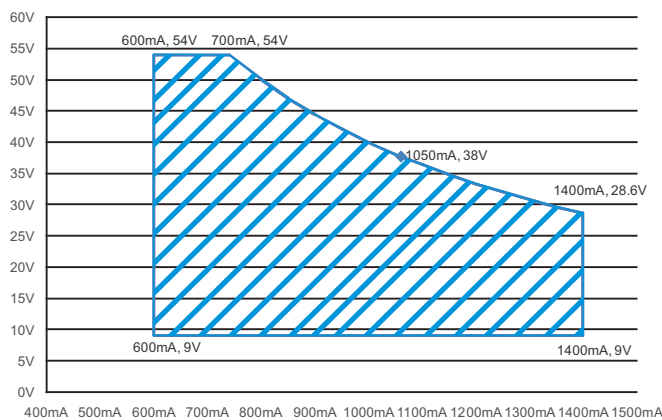

CONSTANT POWER TABLE

XLC-40-H-MA is a multiple-stage constant power driver, selection of output current through DIP S.W is exhibited below.

Vo	Io	DIP S.W		
		1	2	3
9~54V	600mA	----	----	----
9~54V	700mA	----	----	ON
9~50V	800mA	----	ON	----
9~45V	900mA	----	ON	ON
9~38V	1050mA(default)	ON	----	----
9~33V	1200mA	ON	----	ON
9~31V	1300mA	ON	ON	----
9~29V	1400mA	ON	ON	ON

Note: The operating voltage range which show on this table is recommend to use.

OUTPUT LOAD vs TEMPERATURE

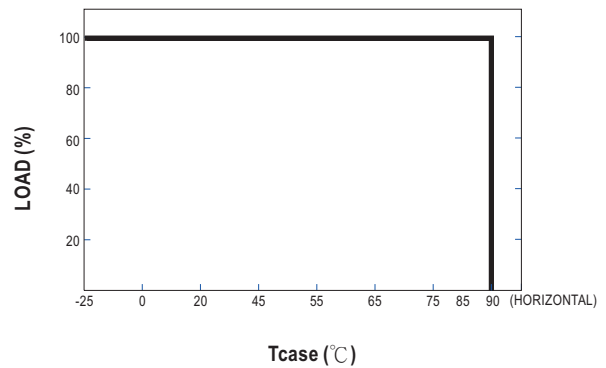
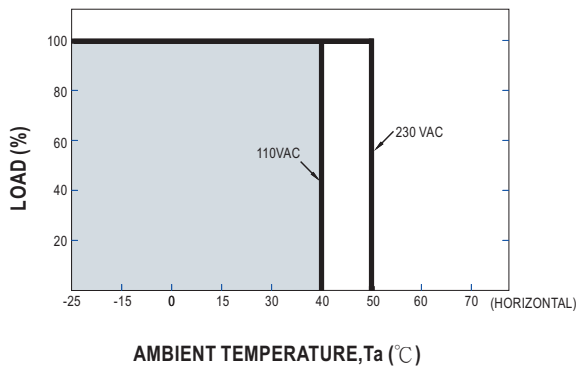

STATIC CHARACTERISTIC

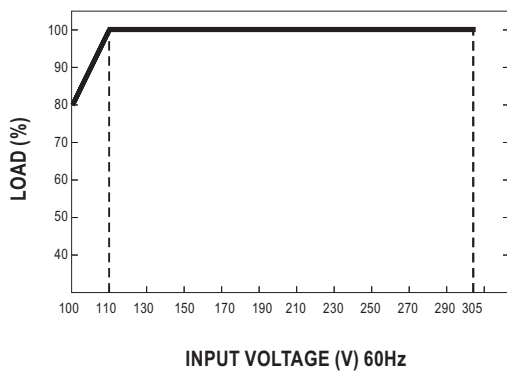

※ De-rating is needed under low input voltage.

LIFE TIME

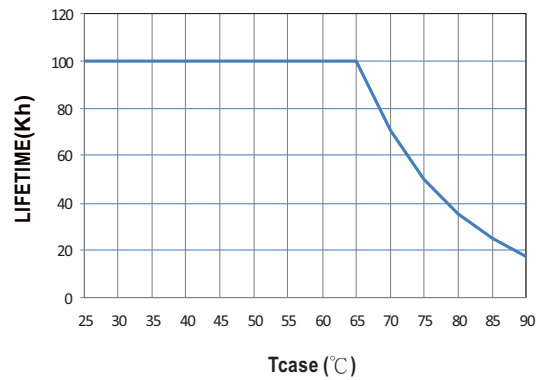

TOTAL HARMONIC DISTORTION (THD)

※ XLC-40-H-MA Model, Tcase at 75°C

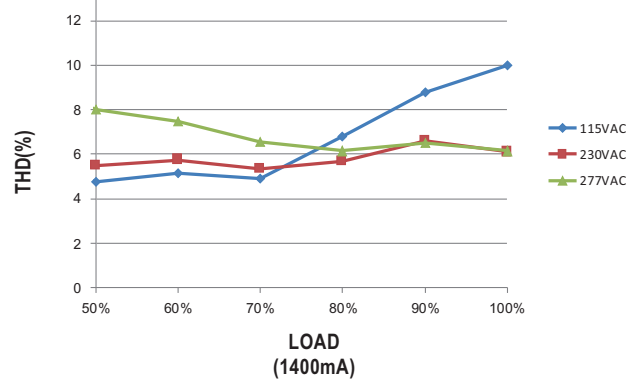
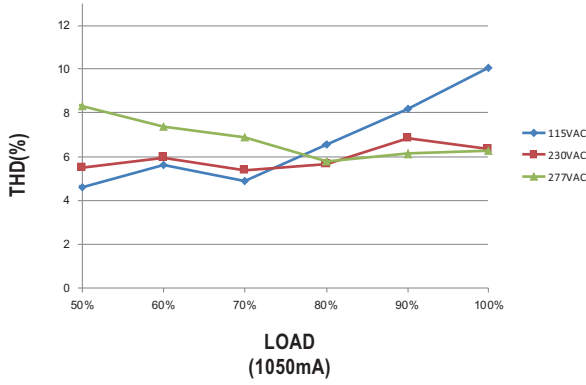

POWER FACTOR (PF) CHARACTERISTIC

※ XLC-40-H-MA Model, Tcase at 75°C

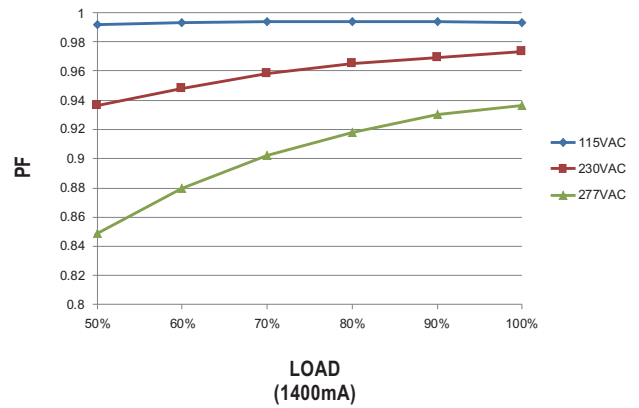
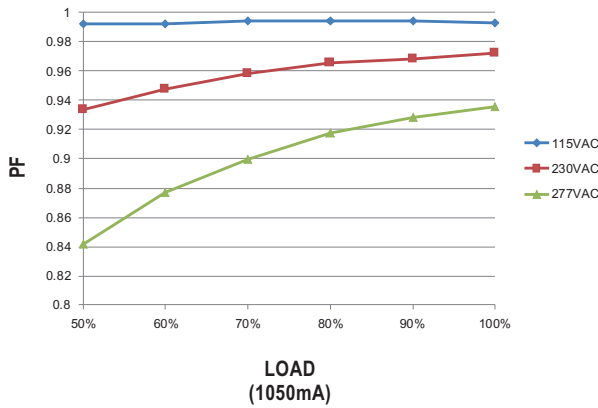

EFFICIENCY vs LOAD

XLC-40-MA series possess superior working efficiency that up to 88% can be reached in field applications.

※ XLC-40-H-MA Model, Tcase at 75°C

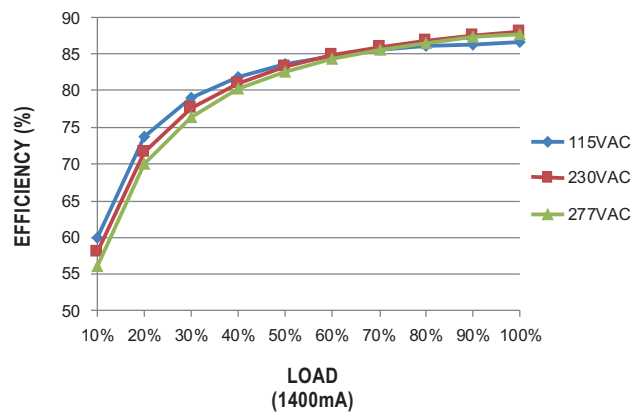
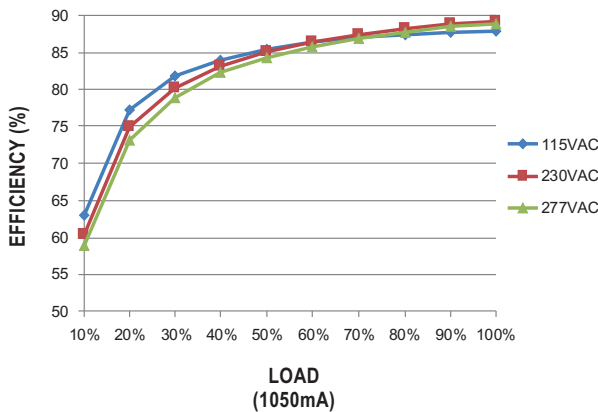

MECHANICAL SPECIFICATION

※ XLC-40-MA series Built-in Type

Case No. XLC-25
Unit: mm Tolerance: ±1

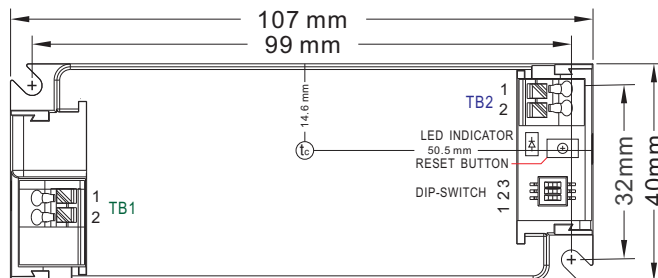

※ Terminal Pin No. Assignment(TB1)

Pin No.	Assignment
1	AC/N
2	AC/L

※ Terminal Pin No. Assignment(TB2)

Pin No.	Assignment
1	+V
2	-V

TB1 wiring:

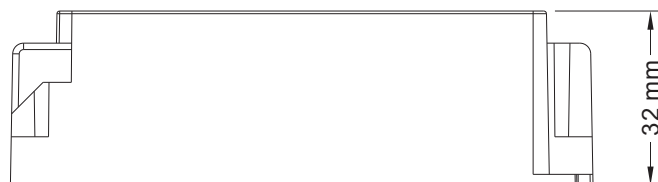
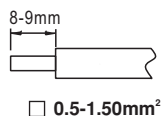

TB2 wiring:

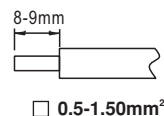

※ XLC-40-MAS series Independent Type

Case No. XLC-25-S
Unit: mm Tolerance: ±1

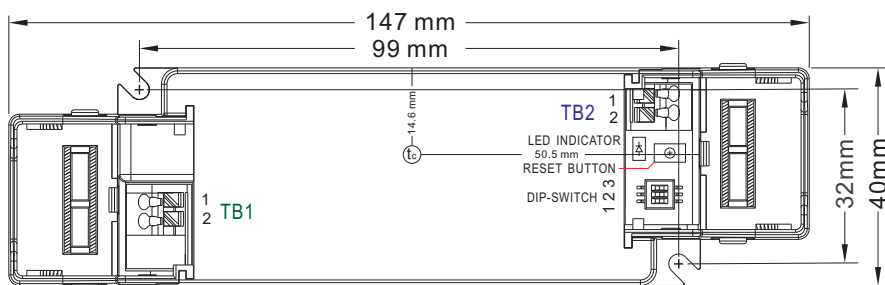

※ Terminal Pin No. Assignment(TB1)

Pin No.	Assignment
1	AC/N
2	AC/L

※ Terminal Pin No. Assignment(TB2)

Pin No.	Assignment
1	+V
2	-V

TB1 wiring:

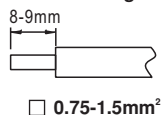

TB2 wiring:

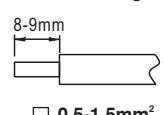

※ LED indicator

Flash slowly	Bluetooth Broadcast running
Flash quickly	Factory Reset running.
Constantly ON	Matter wireless connected
Constantly OFF	Matter wireless disconnected and Bluetooth Broadcast OFF

FACTORY RESET

※ By RESET BUTTON

Press and hold the reset button for 10 seconds. When the LED indicator flashes quickly, release the button. The factory reset will then be completed.



※ By AC ON/OFF

To perform factory reset through AC ON/OFF, the following process must be strictly followed. If the AC ON/OFF process is correct, the output light will flash for 15 seconds. When the flashing stop, it means the factory reset is completed. This operation is consistent with the factory reset effect performed by long-pressing the reset button.

AC ON/OFF process to executes factory reset:

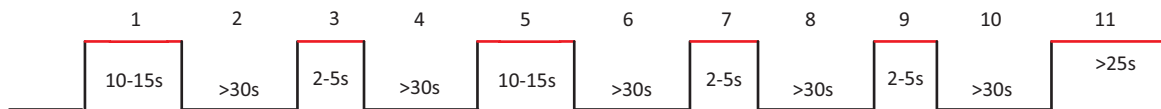

Phase	Duration	AC status
1	10-15s	ON
2	>30s	OFF
3	2-5s	ON
4	>30s	OFF
5	10-15s	ON
6	>30s	OFF
7	2-5s	ON
8	>30s	OFF
9	2-5s	ON
10	>30s	OFF
11	>25s	ON(should wait until output light stop flashing)

If there is a malfunction in the 'AC ON/OFF process', the process can be reset by the following method, starting from stage 1 again.

Method 1: AC ON time exceeds 25 seconds



Method 2: AC ON times for 2-5s and twice



■ PLACEMENT

Mean Well device has an integrated antenna for easy integration. In order to maximize the range in every direction, some design guidelines should be taken into consideration when mounting the device.

The antenna positions of the device are shown in the figure below:

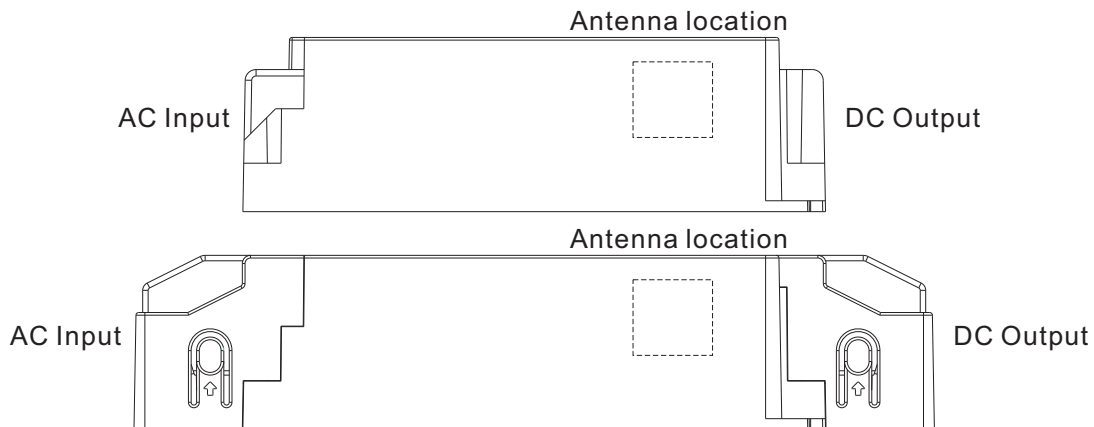

- Keep the device as far away as possible from vertical metal structures.
- When the device is mounted on a metal plate, the antenna should not be obscured, and there needs to be a cutout under the antenna to ensure that the RF signal can be transmitted.
- The device's communication range may be influenced by environmental factors and installation positioning, necessitating on-site adjustments and testing.

■ Installation Manual

Please refer to : <http://www.meanwell.com/manual.html>